

Hot & Cold Water Dispenser

W2-170

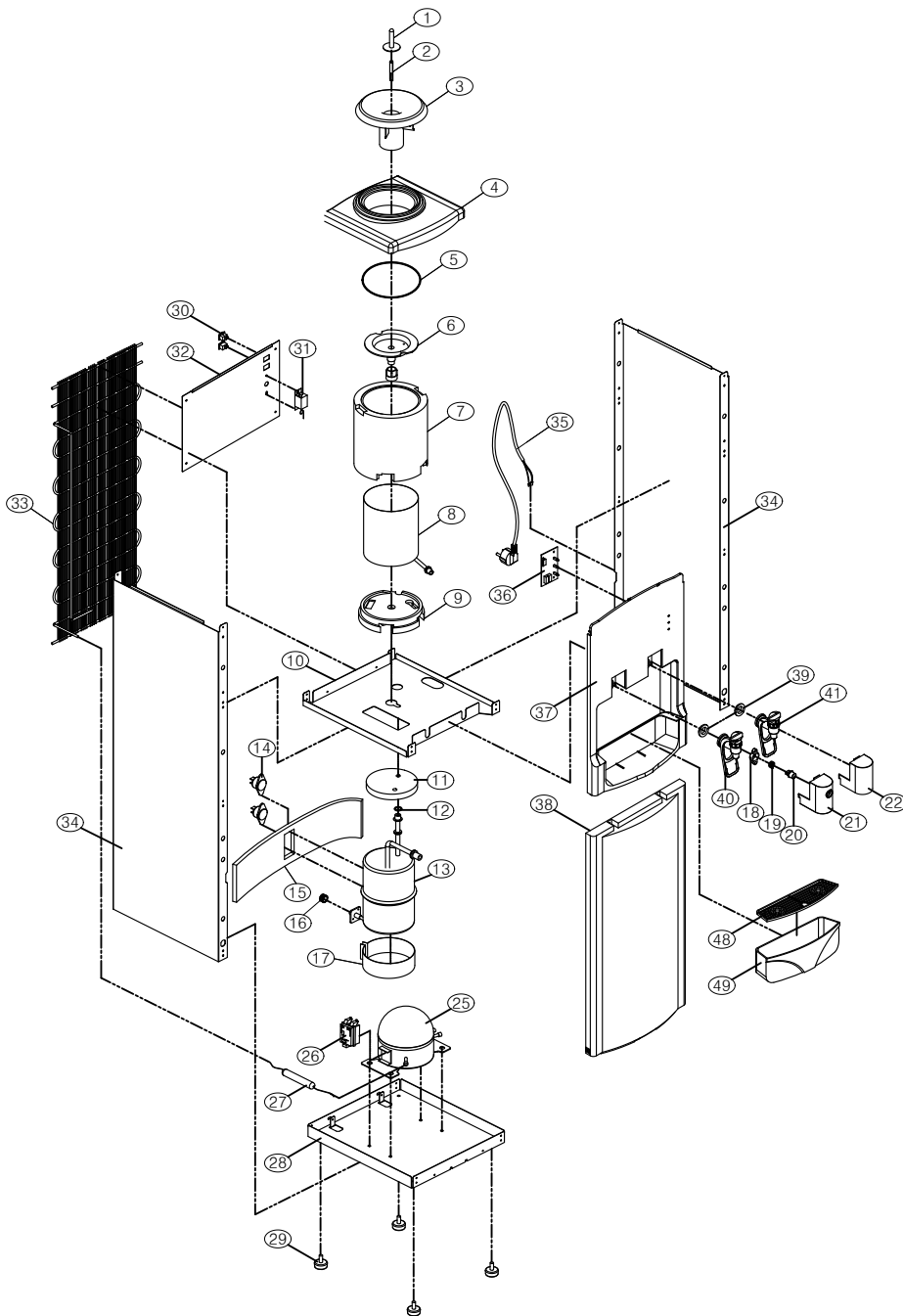

NO	PART NAME	Q'TY
1	Water Guard Pin #1	1
2	Water Guard Pin #2	1
3	Water Guard	1
4	Top Part Panel	1
5	Ring Packing	1
6	Separate Panel & Nut	1
7	Cold Tank Lagging(L)	1
8	Cold Tank	1
9	Cold Tank Lagging(S)	1
10	Middle plate	1
11	Hot tankLagging(S)	1
12	Hot tank O-ring	1
13	Hot tank	1
14	Bimetal	2
15	Hot tank lagging(L)	1
16	Drain valve cover	1
17	Bend heater	1
18	Holder button	1
19	Spring	8
20	Button push	8
21	Cover faucet (Hot)	1
22	Cover faucet (Cold)	1
23	Grill water	1
24	Tray water	1
25	Compressor	1
26	OLP-PTC	1
27	Dryer	1
28	Bottom plate	1
29	Control wheel	4
30	Switch	2
31	Cold thermostat	1
32	Back plate	1
33	Wire condensor	1
34	Side frame	2
35	Power cord	1
36	PCB LED	1
37	Panel front upper	1
38	Panel front under	1
39	Faucet O-ring	1
40	Faucet (Hot)	2
41	Faucet (Cold)	1

WACO Corp.